

V30 Diagnostic Computer

USER MANUAL

Version 1.65

Statement

Copyright © 2008 by AUTOBOSS TECH. INC. (short for "AUTOBOSS"). All rights reserved. No part of this publication can be reproduced, stored in a retrieval system, or transmitted in any form or by any means, electronic, mechanical, photocopying, recording or otherwise, without the prior written permission of AUTOBOSS. The information contained herein is designed only for the use of this unit. AUTOBOSS is not responsible for any use of this information as applied to other units.

Neither AUTOBOSS nor its affiliates shall be liable to the purchaser of this unit or third parties for damages, losses, costs, or expenses incurred by purchaser or third parties as a result of: accident, misuse, or abuse of this unit, or unauthorized modifications, repairs, or alterations to this unit, or failure to strictly comply with AUTOBOSS operating and maintenance instructions.

AUTOBOSS shall not be liable for any damages or problems arising from the use of any options or any consumable products other than those designated as Original AUTOBOSS Products or AUTOBOSS Approved Products by AUTOBOSS.

General Notice: Other product names used herein are for identification purposes only and may be trademarks of their respective owners. AUTOBOSS disclaims any and all rights in those marks.

The V-30 Diagnostic Computer can only operated by qualified technicians.

Trade mark

AUTOBOSS is a registered trademark of AUTOBOSS TECH. INC. (short for AUTOBOSS) in China and other countries. All other AUTOBOSS trademarks, service marks, domain names, logos, and company names referred to in this manual are either trademarks, registered trademarks, service marks, domain names, logos, company names of or are otherwise the property of AUTOBOSS or its affiliates. In countries where any of the AUTOBOSS trademarks, service marks, domain names, logos and company names is not registered, AUTOBOSS claims other rights associated with unregistered trademarks, service marks, domain names, logos, and company names. Other products or company names referred in this manual may be trademarks of their respective owners. You may not use any trademark, service mark, domain name, logo, or company name of AUTOBOSS or any third party without permission from the owner of the applicable trademark, service mark, domain name, logo, or company name.

You may contact AUTOBOSS by visiting AUTOBOSS at www.AUTOBOSS.net , or writing to AUTOBOSS, No.1102, Building B of Futian Tian'an Hi-Tech Venture Park, Futian District, Shenzhen, China, to request written permission to use Materials on this manual for purposes or for all other questions relating to this manual.

V30 User Manual instructions

- Please read this user manual carefully before using the scanner.
- The current user manual is based on the current features and functions available. Any new added features and functions of V30 Diagnostic Computer will be added to the user manual in the future. Updated versions of user manual will be available to download at AUTOBOSS website (<http://www.AUTOBOSS.net>).
- When reading the manual, please pay special attention to the words “Note”, “Caution” or “Warning”, read them carefully for appropriate operation.

V30 Diagnostic Computer main unit maintenance:

- Avoid shaking or dismantling as it may damage the internal components;
- Do not use hard or sharp objects to touch the LCD screen; do not use excessive force; do not expose the screen to strong sunlight for a long period;
- Caution: keep it away from water, moisture, high temperature or very low temperature;
- If necessary, calibrate the screen before testing to ensure the accuracy of LCD performance;
- Keep the main unit away from strong magnetic fields.

Operation Instructions

- For safe operation please follow the instructions below;
- Keep the scanner away from heat or fumes when using it;
- If the vehicle battery contains acid, please keep your hands and skin or fire sources away from the battery during testing;
- Exhaust gas of vehicle contains harmful chemicals, please ensure adequate ventilation;
- Do not touch the cooling system components or exhaust manifolds when engine is running due to the high temperatures reached;
- Make sure the car is securely parked and the selector is at P or N position to prevent the vehicle from moving when engine starts;
- Make sure the (DLC) diagnostic link connector is functioning properly before starting the test; otherwise the scanner may be damaged. AUTOBOSS suggests you test the Power/Earth with Multimeter first;
- Do not switch off the power or unplug the connectors during testing, otherwise you may damage the ECU or scanner.

CONTENTS

1 Introduction	1
1.1 FUNCTION AND FEATURE	1
1.2 LAYOUT OF MAIN UNIT	1
1.3 TECHNICAL PARAMETERS	2
1.4 CONFIGURATION	2
2 Operation	8
2.1 POWER SUPPLY & CABLE CONNECTION.....	8
2.1.1 Power Supply	8
2.1.2 Cable Connection	8
2.2 INTERFACE INSTRUCTION	9
2.2.1 Starting Interface	9
2.2.2 Touch Screen Calibration.....	9
2.2.3 Diagnose Program	10
2.2.4 System Setting	11
2.2.5 Self Test	13
2.2.6 PC LINK	13
2.2.7 Version Information	13
2.3 SOFTWARE UPGRADING	15
2.3.1 Download and Install “V30 Update Client”.....	15
2.3.2 Check V30 S/N and Password	16
2.3.3 Upgrading Instructions	17
2.4 TO PRINT SAVED FILES FROM SD CARD	21
3 Test Procedure	23
3.1 Engine ECU Testing Methods.....	23
3.1.1 Testing Description.....	23
Order Information	31

1 Introduction

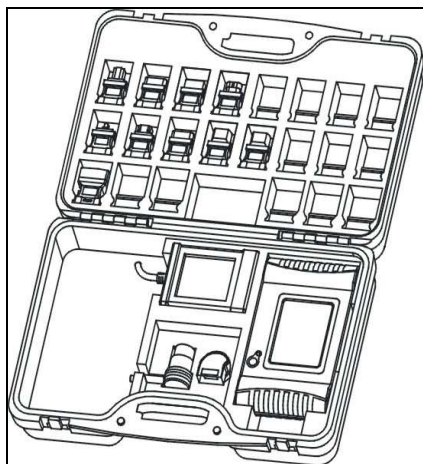

1.1 Function and Feature

- OE level coverage for European, Asian, American and Chinese cars
- Supports Multi-language
- CAN-BUS with high/low speed
- One OBDII connector for all CAN bus systems
- Frequent software update online
- High resolution VGA color TFT display
- Windows CE Operating System
- Quick Test function to test most vehicle systems
- Demo Mode for many OEM's
- Data graphing
- Self-check function

1.2 Layout of Main Unit

The main unit layout is as shown in left picture.

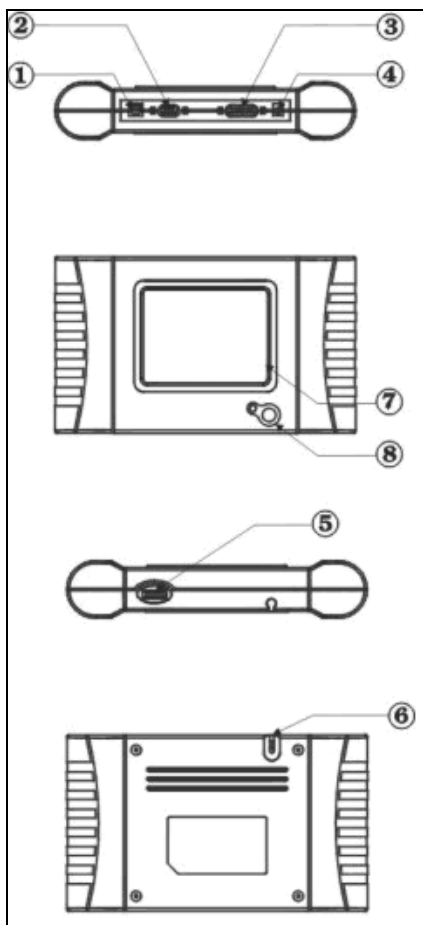



- ① USB Port
- ② COM Port
- ③ Diagnostic Port
- ④ Power Port
- ⑤ SD slot
- ⑥ Touch Pen / Stylus slot
- ⑦ Touch Screen
- ⑧ Power Switch

1.3 Technical Parameters



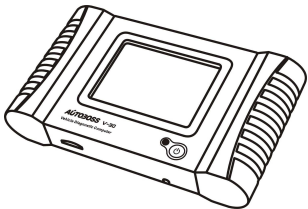
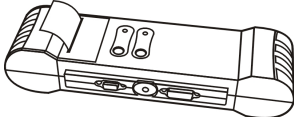
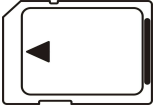

- **CPU:** SAMSUNG ARM9 2410A, 200MHz;
- **Memory:** 64M;
- **Flash card:** SD card, 1G
- **Display:** 5.6" VGA (640×480) ultra bright TFT;
- **Power supply:** DC 8~12V, AC 110~250V 50Hz;
- **Port:** Diagnosis port, COM port, USB port, Power Port;
- **Operating system:** WINDOWS CE;
- **Storage temperature:** -30~90°C;
- **Working temperature:** -10~80°C;
- **Humidity:** <90%.

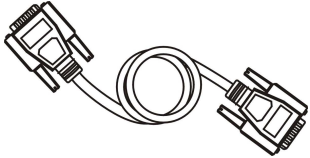
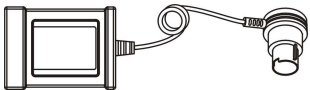
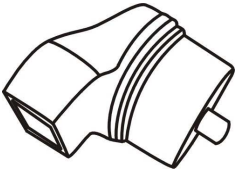
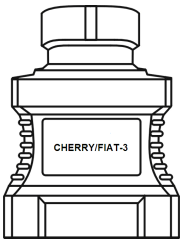
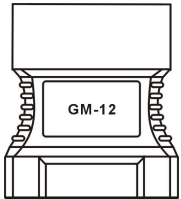

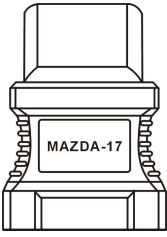
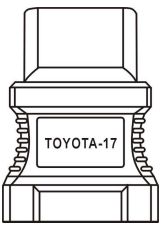
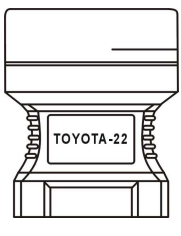
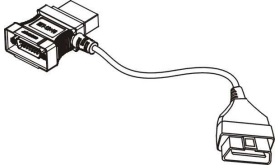
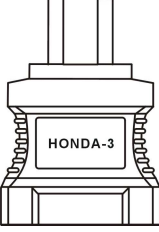
1.4 Configuration

Picture	Item	Description
	<p>Name: V30 main unit Quantity: 1</p>	<p>Function: Display testing procedures and information</p>
	<p>Name: V30 mini printer Quantity: 1 Note: Optional</p>	<p>Function: for printing diagnostic information.</p>
	<p>Name: SD card Quantity: 1</p>	<p>Function: Storage of Diagnostic programs and saved files</p>

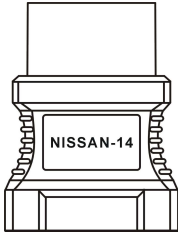
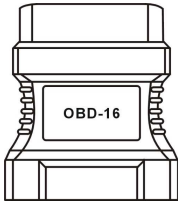
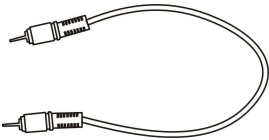
Picture	Item	Description
	<p>Name: Touch pen / Stylus Quantity: 1</p>	<p>Function: For touch screen operation</p>
	<p>Name: Main Cable Quantity: 1</p>	<p>Function: Connect the main unit & connectors for diagnosis</p>
	<p>Name: BENZ-38 connector Quantity: 1</p>	<p>Function: Used for testing Mercedes-Benz vehicles equipped with a circular 38-pin DLC</p>
	<p>Name: BMW-20 connector Quantity: 1</p>	<p>Function: Used for testing BMW vehicles equipped with a 20-pin DLC</p>
	<p>Name: Chery/Fiat -3 connector Quantity: 1</p>	<p>Function: Used for testing FIAT vehicles equipped with a 3-pin DLC</p>
	<p>Name: GM-12 connector Quantity: 1</p>	<p>Function: Used for testing GM/DAEWOO vehicles equipped with a 12-pin DLC</p>

Picture	Item	Description
 <p>A diagram of a KIA-20 connector, which is a rectangular 20-pin DLC connector with a label 'KIA-20' on its front face.</p>	<p>Name: Kia-20 connector Quantity: 1</p>	<p>Function: Used for testing KIA vehicles equipped with a 20-pin DLC</p>
 <p>A diagram of a MAZDA-17 connector, which is a rectangular 17-pin DLC connector with a label 'MAZDA-17' on its front face.</p>	<p>Name: Mazda-17 connector Quantity: 1</p>	<p>Function: Used for testing MAZDA vehicles equipped with a 17-pin DLC</p>
 <p>A diagram of a TOYOTA-17 connector, which is a semi-circular 17-pin DLC connector with a label 'TOYOTA-17' on its front face.</p>	<p>Name: TOYOTA-17 connector Quantity: 1</p>	<p>Function: Used for testing TOYOTA/LEXUS vehicles equipped with a semi-circular 17pin DLC</p>
 <p>A diagram of a TOYOTA-22 connector, which is a rectangular 22-pin DLC connector with a label 'TOYOTA-22' on its front face.</p>	<p>Name: TOYOTA-22 connector Quantity: 1</p>	<p>Function: Used for testing Toyota and Lexus vehicles with a rectangular 22-pin DLC</p>
 <p>A photograph of a MIT-12+16 connector cable, showing a small rectangular connector on one end and a larger, multi-pin connector on the other, connected by a thin cable.</p>	<p>Name: MIT-12+16 connector Quantity: 1</p>	<p>Function: Used for testing Mitsubishi and Hyundai vehicles equipped with a 12-pin or 16-pin DLC</p>
 <p>A diagram of a HONDA-3 connector, which is a rectangular 3-pin DLC connector with a label 'HONDA-3' on its front face.</p>	<p>Name: HONDA-3 connector Quantity: 1</p>	<p>Function: Used for testing HONDA and ACURA vehicles equipped with a 3-pin DLC</p>

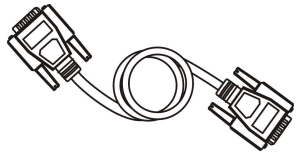
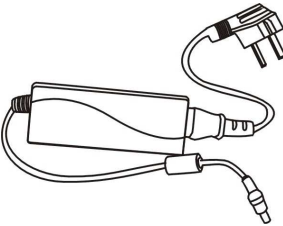
Picture	Item	Description
	<p>Name: BENZ-4 connector Quantity: 1</p>	<p>Function: Used for testing Mercedes-Benz vehicles before 1997 with flash codes. Those vehicles are usually equipped with either a rectangular 8-pin or 16-pin</p>
	<p>Name: AUDI-4 connector Quantity: 1</p>	<p>Function: Used for testing VW/AUDI vehicles with a 4-pin (2x2) DLC</p>
	<p>Name: NISSAN-14 connector Quantity: 1</p>	<p>Function: Used for testing Nissan and Infiniti vehicles equipped with a 14-pin DLC</p>
	<p>Name: OBD-16 connector Quantity: 1</p>	<p>Function: Used for testing all vehicles compliant with OBDII, EOBD and J1962 with the 16-pin DLC</p>
	<p>Name: Jumper Quantity: 1</p>	<p>Function: Short circuit test for flash code reading</p>
	<p>Name: Battery power cable Quantity: 1</p>	<p>Function: Provide the power supply via battery</p>

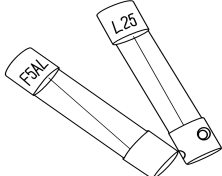
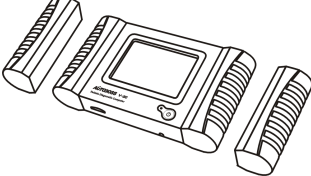
Picture	Item	Description
	<p>Name: Cigarette lighter power cable Quantity: 1</p>	<p>Function: Provide the power supply via cigarette lighter on the car</p>
	<p>Name: Serial cable Quantity: 1</p>	<p>Function: Connect the main unit and PC base</p>
	<p>Name: DC adaptor Quantity: 1</p>	<p>Function: Provide 12V DC voltage</p>
	<p>Name: SD Card reader Quantity: 1</p>	<p>Function: Read SD card for software update or SD card reading and writing</p>
	<p>Fuse 5A 30*6</p>	<p>Spare parts</p>
	<p>Fuse 5A 20*5</p>	<p>Spare parts</p>
	<p>Name: main unit rubber boot Quantity: 1 pair</p>	<p>Function: To provide additional protection to scan tool. Note: Optional</p>

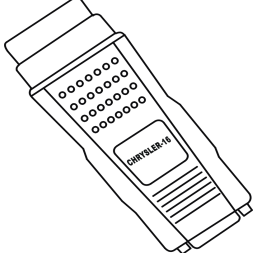
Picture	Item	Description
	<p>Name: Benz-14 pin connector Quantity: 1</p>	<p>Function: Used to test Mercedes-Benz Sprinter Note: Optional</p>
	<p>Name: Chrysler-16 connector Quantity: 1 Note: Optional</p>	<p>Function: Used to test Chrysler car with CCD protocol</p>

NOTE: Configuration varies as per software package. For complete configuration, please refer to the relevant packing list.

2 Operation

2.1 Power Supply & Cable Connection

2.1.1 Power Supply

There are 3 ways to get power for V30 Diagnostic Computer. From:

- ① Vehicle DLC, no external power supply needed
- ② Cigarette lighter
- ③ Battery

2.1.2 Cable Connection

How to get power supply:

- ① Use Cigarette lighter or Battery cable to power main unit if DLC is not self-powered.
- ② No external power supply needed if DLC is self-powered.
- ③ **NOTE: ALL 16 PIN DLC connectors have 12v supply and earth for scan tools.**

How cables are connected:

- ① Check the type of DLC to see if external power supply is required.
- ② Select corresponding connectors for car make and DLC.
- ③ Connect one end of main cable to the main unit and the other end to the connector.
- ④ Plug the connector in to the DLC on car.
- ⑤ Turn on the unit using the power button to start testing.

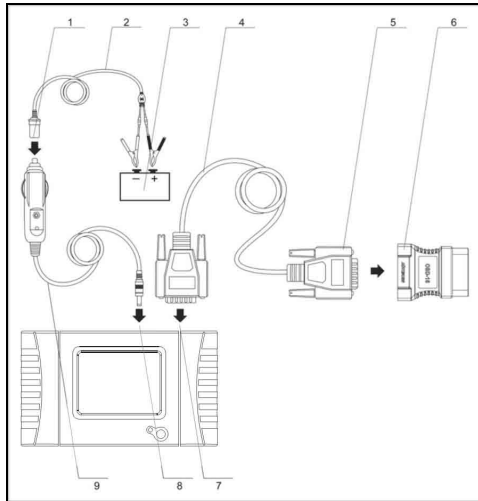

- 1. Cigarette lighter plug
- 2. Battery cable
- 3. Battery
- 4. Main cable
- 5. Main cable adaptor
- 6. Connector
- 7. Diagnostic connector port
- 8. Power port
- 9. Cigarette lighter



2.2 Interface Instruction

2.2.1 Starting Interface

The screen shown on the left picture will appear on the screen after the scanner is switched on.



2.2.2 Touch Screen Calibration

Several seconds after power is switched on, the screen will go into calibration mode. Click anywhere on the screen to start calibration if necessary.

Note: Just wait for several seconds until the diagnosis program runs if screen calibration is not required.

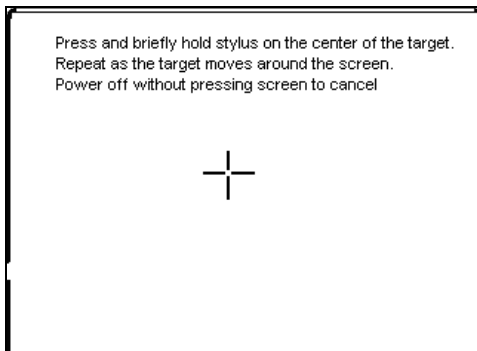

Click on the center of cross with touch pen according to the instruction on the screen. Repeat the operation as the cross moves until the setting is finished.



After the scanner is started, you will come to the screen shown on the left picture which includes the functions of [Diagnose], [Setting], [Self-check] and [PC link], [Version]] and [Power off].



2.2.3 Diagnose Program

After entering [Diagnose], you will enter the diagnostic screen where you can select the region of vehicle manufacturer required: China, Europe, Asia, America and Others (OBD II /EOBD).

Europe: This section includes the diagnostic programs for European vehicles.

Asia: This section includes the diagnostic programs for Asian and Korean vehicles.

America: This section includes the diagnostic programs for US vehicles.

China: This section includes the diagnostic programs for Chinese vehicles.

Others: This diagnostic program can test all vehicles with OBD II /EOBD and CAN-OBD.



2.2.4 System Setting

Click on the button **[Setting]** to enter settings for language, time, download and unit.

2.2.4.1 Language Setting

V30 supports Multilanguage. Choose any language needed under **[working language]** and press **[OK]** to finish language setting.

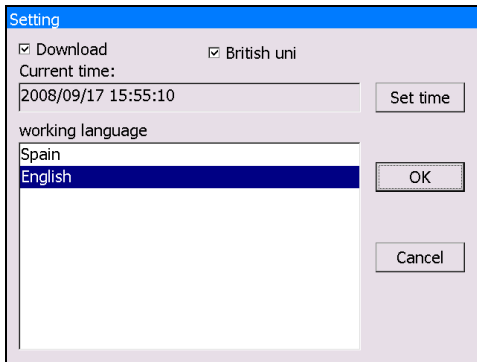

2.2.4.2 Time Setting

Click on **[Set time]** to enter the menu for time selection. By clicking on signs of “▼” or “▲”, numbers will increase or decrease correspondingly.

Click on the button **[Set time]** to finish setting. The dialog box **“Set system time successfully!”** will popup.

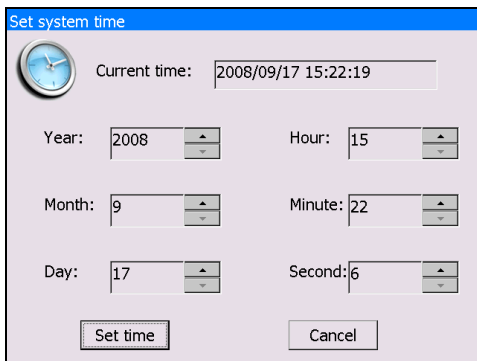

Click **[OK]** to save the setting or **[Cancel]** to exit.

2.2.4.3 Download Communication Protocol

This function is for communication unit initialization. When selected, a progress bar will be shown under the version information of each diagnostic program to indicate status of program download.

NOTE: It is not recommended to use unless directed by SPX Autoboss technical service personnel.

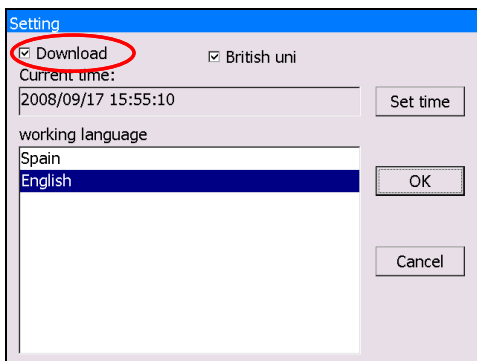

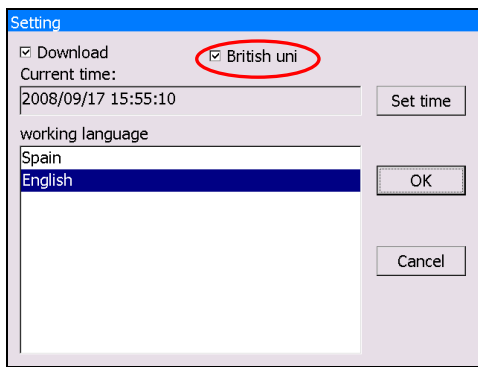

2.2.4.4 Display Data Stream in British Unit

Data stream will be displayed in British unit after **[British unit]** is chosen.

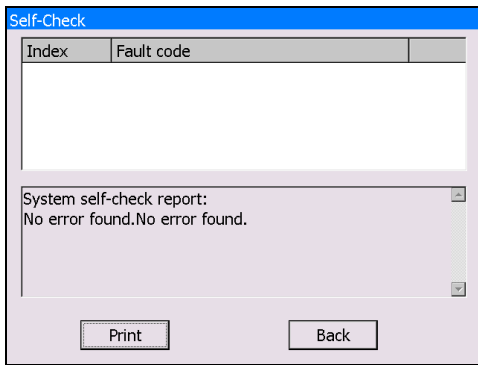

2.2.5 Self Test

This is for hardware checking. Click on the button **[Self check]** and any hardware faults will be displayed. Please contact technical support if a hardware problem is reported.

If there are no hardware errors, the checking result will be **“System Self test report: No error found.”**

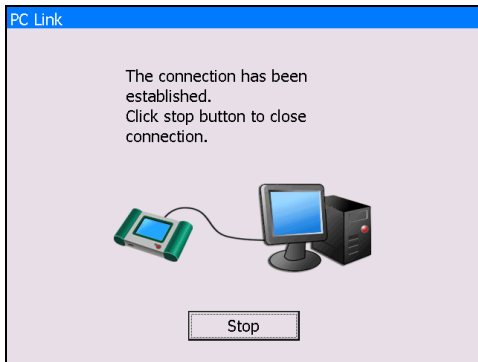

2.2.6 PC LINK

PC Link is not available at this time. The V30 diagnostic computer can be operated via PC/Laptop by installing PC LINK software.

Connect V30 main unit and PC with the COM cable and run the PC LINK software on the PC; you will be able to test vehicles from the PC interface as shown on the left.

Note: Please contact the local AUTOBOSS distributor for availability of PC LINK software

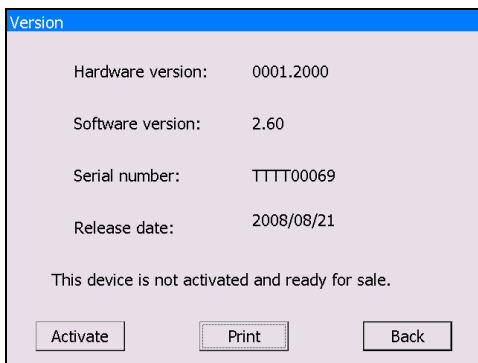

2.2.7 Version Information

Click on the button **[Version]** in main menu to get the information of Hardware version, Software Serial number, Release date, etc

Click **[Back]** to exit.

2.2.8 Power Off



Click on **[Exit]** of main menu to switch off the V30 main unit. Warning dialog box “Do you want to shutdown this device?” will popup. Click **[No]** to return to the operating menu. Click **[Yes]** to switch off the main unit.



2.3 Software Upgrading

2.3.1 Download and Install “V30 Update Client”

Step1: Visit AUTOBOSS website at <http://www.AUTOBOSS.net>

Step2: Enter English website

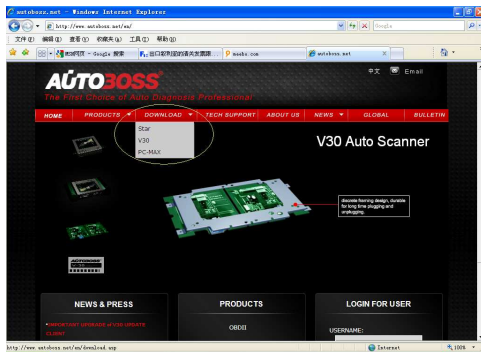

Step3: Click on **[V30]** under the button **[Download]** to enter download screen as shown in left image.

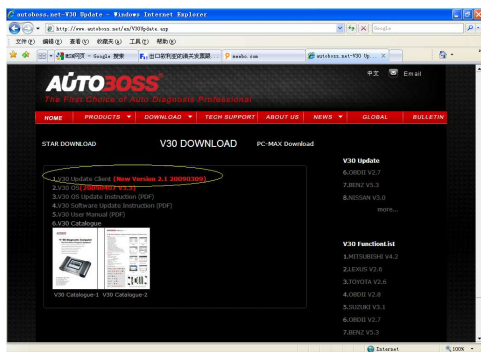

Step4: Click on the option **[V30 Update Client]** to download the update client to your PC.

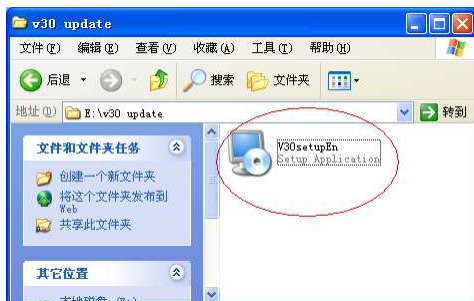

A file named **V30setupEn.exe** will be saved in your PC.

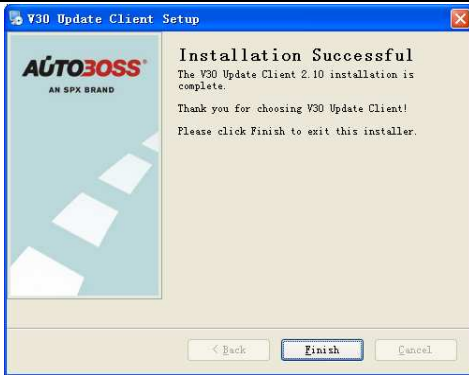

Step 5: Double click on this file to install "V30 update client" step by step until you see the image shown on the left.

Note: Just click on the button [Next] in each step during the installation. We advise you to keep everything as default. Please remember to input your name and company name.

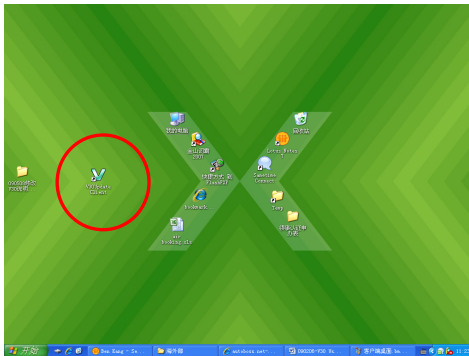

After finishing the installation, you will see the icon shown below on your desktop.



Download of "V30 update client" is finished.

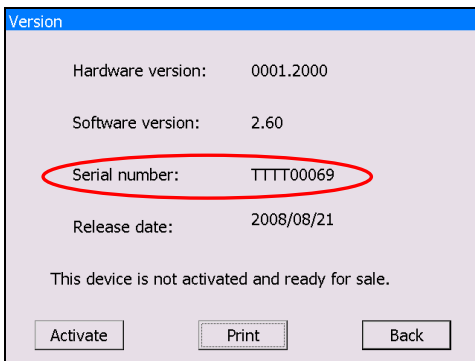

2.3.2 Check V30 S/N and Password

Check the S/N: Please refer to **2.2.7 Version information** in this manual;

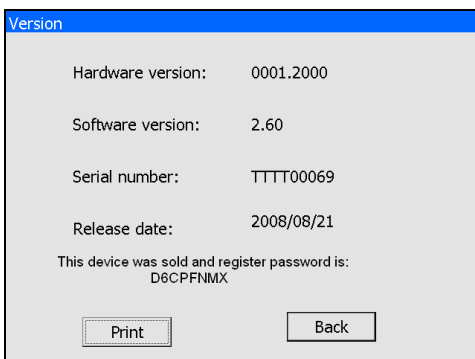

How to get password:

Click on the button **[Activate]** to get the original register password as shown in left image.

2.3.3 Upgrading Instructions

2.3.3.1 Run V30 update client program

Step1: Take out the SD card from main unit, plug it into the USB SD card reader and connect to PC. Step 2: Double click to run the **V30 update client** program on your PC and go to update screen as shown in Fig 2-1.

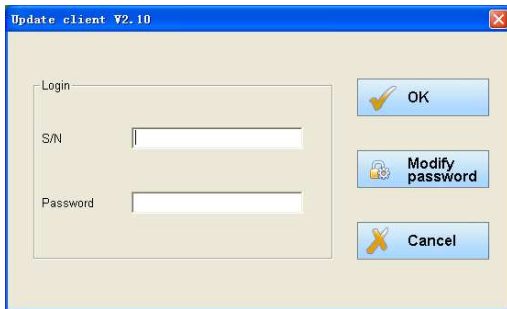

Fig 2-1 Login screen

2.3.3.2 Login the Server

- (1) Input the serial number and password then click on the **[OK]** button to connect to server. It takes some seconds before the download is finished like Fig 2-2.
- (2) The default server is 'www.AUTOBOSS.net'. Normally you do not have to change the server.

Note:

- ① Be sure that both S/N and password are correct. Please pay attention, the letters are case sensitive!
- ② If login takes a long time because of low internet speed, you can exit and retry;
- ③ Internet firewall might affect the login. If login fails, please make sure you have an internet connection, and ensure any installed firewall is not blocking the connection to the server. For detailed operation instructions, please contact technical support.

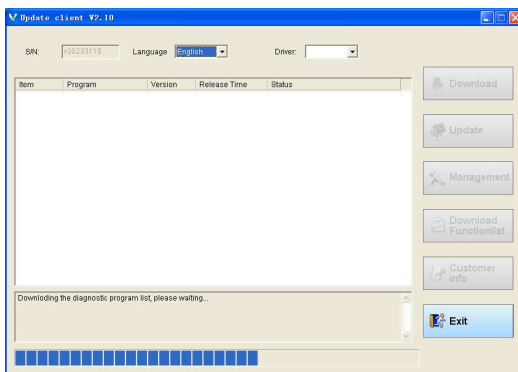

Fig 2-2 Downloads progress

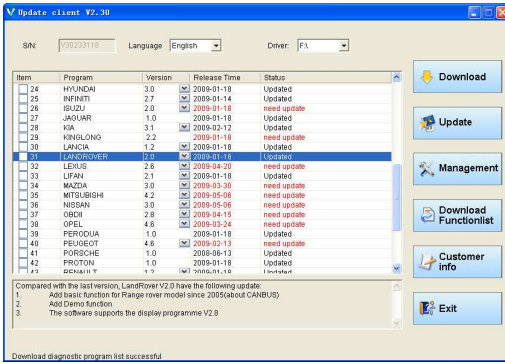

Fig 2-3 Program list screen

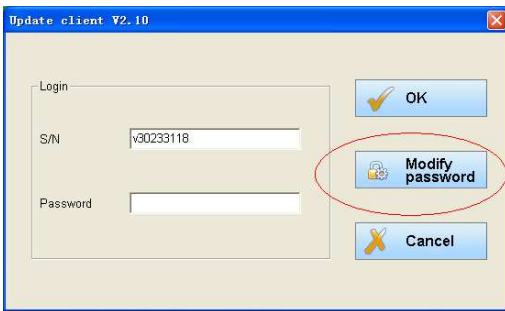

Fig 2-4 Modify password

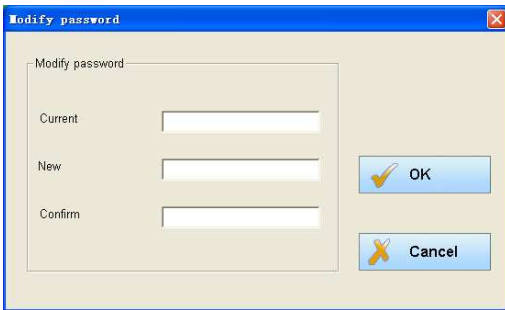

Fig 2-5 Modify password screen

(4) After download is finished, all updates available will be displayed as shown in Fig 2-3.

(5) The update client will automatically identify new updates available for your V30.

2.3.3.3 Modify Password

After initial login, users can change original registered password.

Operation instruction:

(1) After inputting the serial number, click on **[Modify password]** as shown in Fig 2-4 to go to the next step as Fig 2-5.

(2) Input the current password and new password, then click on **[OK]** for confirmation.

Note: Please keep the password in a secure location. If you forget the password, please contact AUTOBOSS or technical support.

User information

User information

First name: LEE

Last name: TOM

Company name: AUTOBOSS TECH INC

Tel: 0755-82193298

Fax: 0755-82170248

Mob:

Email: MARKETING@AUTOBOSS.NET

Distributor code: SZ-HDC003

Address:

Country: CHINA

State/Province: GUANG DONG

City: SHENZHEN

Street No: BLDG.304, SHANGBU INDUSTRIAL PARK, ZHENXING RD.

Poster code: 518028

OK Cancel

Fig2-6 Input customer info screen

2.3.3.4 Input Customer Information

You must fill in your personal information when you first login to V30 update client; otherwise you will not be able to download updates.

Operation instruction:

Click on the button **[Customer info]** after login succeeds. You can see the screen as shown in Fig. 2-6. Input your information to the relevant spaces and click **[OK]** to save the information.

V Update client V2.10

S/N: 090233118 Language: English Driver: E1

Item	Program	Version	Release Time	Status
1	DISPLAY	2.96	2009-04-27	Waiting
2	ACURA	3.3	2009-04-29	Waiting
3	AMFORD	2.2	2009-01-18	Waiting
4	AUX	1.3	2009-03-12	Waiting
5	AUSFORD	1.0	2009-01-18	Waiting
6	BBOC	1.9	2009-03-24	Waiting
7	BENZ	5.3	2009-04-10	Waiting
8	BMW	4.1	2009-01-18	Waiting
9	BYD	2.25	2009-01-18	Waiting
10	CHANA	2.6	2009-01-18	Waiting
11	CHANGHE	3.2	2009-11-05	Waiting
12	CHERY	3.65	2009-01-18	Waiting
13	CHRYSLER	1.8	2009-02-25	Waiting
14	CITROEN	3.4	2009-01-18	Waiting
15	DAIHATSU	1.0	2009-01-18	Waiting
16	EURFORD	2.4	2009-03-24	Waiting
17	FDOC	2.05	2009-01-18	Waiting
18	FIAT	1.4	2009-01-18	Waiting
19	FUTIAN	2.3	2009-01-18	Waiting
20	HONDA	1.4	2009-01-18	Waiting

1. Update the adaptation function of the CAN system.
2. Add VAO ID.

Download diagnostic program list successful

Download Update Management Download Functionlist Customer Info Exit

Fig.2-7 Download screen

2.3.3.5 Software Download

After user information is saved, you can download the programs needed.

Operation instruction:

- Choose the language version on the top and tick the small box before the relevant program as Fig. 2-7;
- Click on **[Download]** in right column to enter download status.

Note: A maximum of 10 items can be chosen to download simultaneously.

- The software will be downloaded to your PC hard drive automatically.

V Update client V2.10

S/N: 090233118 Language: English Driver: E1

Item	Program	Version	Release Time	Status
1	DISPLAY	2.96	2009-04-27	Waiting
2	ACURA	3.3	2009-04-29	Downloaded 61%
3	AMFORD	2.2	2009-01-18	Waiting
4	AUX	3.3	2009-03-12	Waiting
5	AUSFORD	1.0	2009-01-18	Waiting
6	BBOC	1.9	2009-03-24	Waiting
7	BENZ	5.3	2009-04-10	Waiting
8	BMW	4.1	2009-01-18	Waiting
9	BYD	2.25	2009-01-18	Waiting
10	CHANA	2.6	2009-01-18	Waiting
11	CHANGHE	3.2	2009-11-05	Waiting
12	CHERY	3.65	2009-01-18	Waiting
13	CHRYSLER	1.8	2009-02-25	Waiting
14	CITROEN	3.4	2009-01-18	Waiting
15	DAIHATSU	1.0	2009-01-18	Waiting
16	EURFORD	2.4	2009-03-24	Waiting
17	FDOC	2.05	2009-01-18	Waiting
18	FIAT	1.4	2009-01-18	Waiting
19	FUTIAN	2.3	2009-01-18	Waiting
20	HONDA	1.4	2009-01-18	Waiting

1. Update the adaptation function of the CAN system.
2. Add VAO ID.

Download diagnostic program list successful

Download Update Management Download Functionlist Customer Info Exit

Fig.2-8 Download screen 2

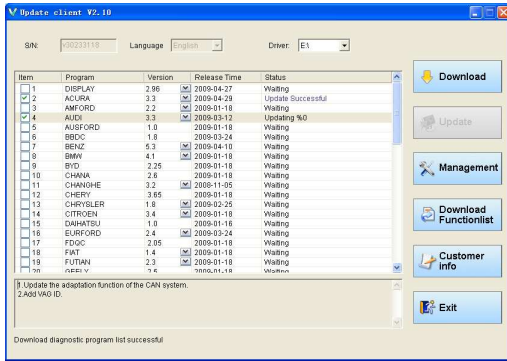

Fig.2-9 Software installation screen

2.3.3.6 Update

- (1) Take out the SD card from V30 main unit;
- (2) Put the SD card into SD Card reader;
- (3) Connect the Card-Reader to PC USB port;
- (4) Select the SD card driver on the top-right side of software installation screen as shown in Fig.2-9;
- (5) Click on the button **[Update]**, the selected programs already downloaded to your PC hard drive will be installed on SD card automatically.

Note: Make sure the update destination is the SD card driver. To confirm this, please enter “My computer” on the PC to verify the content in SD card.

2.3.3.7 Software Management

You can delete old versions of software on the SD card by software management.

Operation instruction:

Click on the button **[Management]** to enter the screen shown in Fig. 2-10. Select the software that is not needed and click on **[Delete]**. The selected software will be uninstalled automatically.

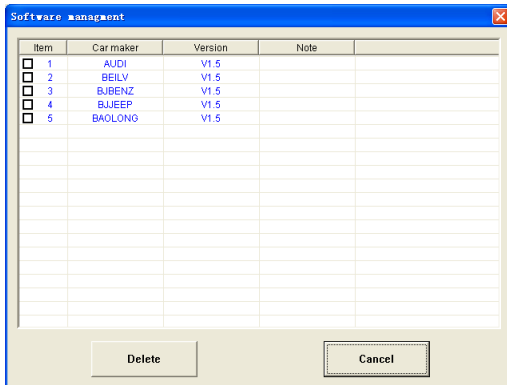
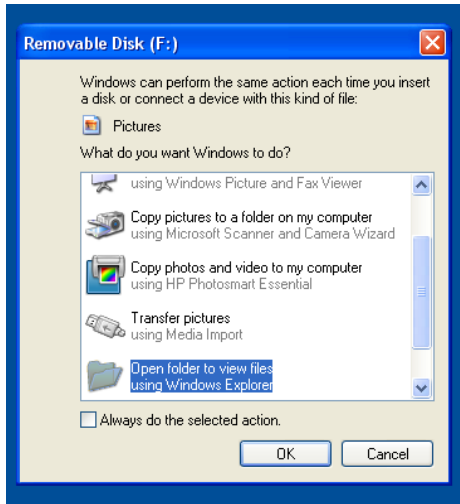

Fig.2-10 software installation screen

2.3.3.8 Exit

After finishing all of the steps, click on **[Exit]** to exit the update client.

2.4 USE YOUR PC TO PRINT SAVED FILES FROM SD CARD



- (1). Insert SD card in SD card reader
- (2). Plug SD card reader into USB port of PC
- (3). Window as shown will pop up, select “open folder to view files” press “OK”

NOTE: You can also obtain a printout by pressing “Print” with the optional mini printer installed on the V30.

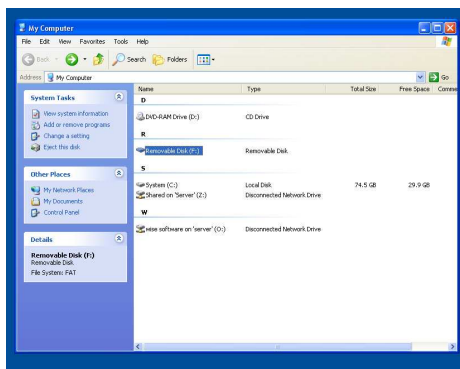

- (4). If the above window does not appear- go to “my computer”, double click on the icon for “Removable disc (F:)” (NOTE: Drive letter may vary depending on assignment of letters by Windows.)

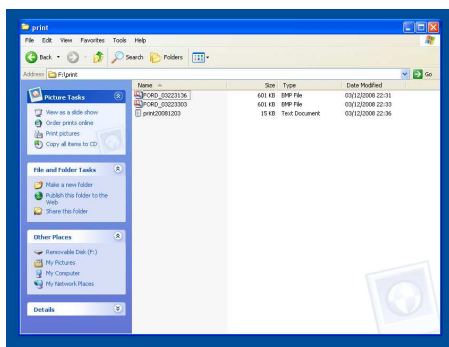

- (5). Double click on “PRINT” folder and choose file required, double click to open file.

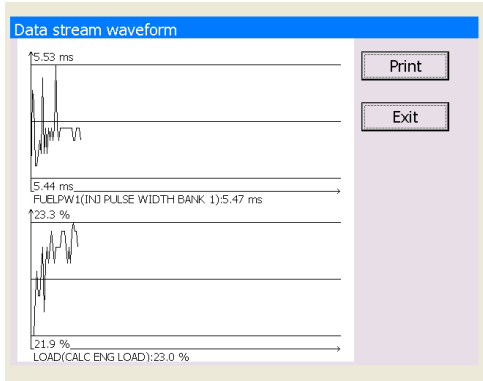

(6). Depending on which program your PC has opened the file with, print using printer icon or select “File” then “Print” from top taskbar

3 Test Procedure



3.1 Engine ECU Testing Methods

3.1.1 Testing Description

- (1) Power up and turn on the scanner;
- (2) Click on **[Diagnose]** → **[Europe]** to enter screen as shown on the left image;

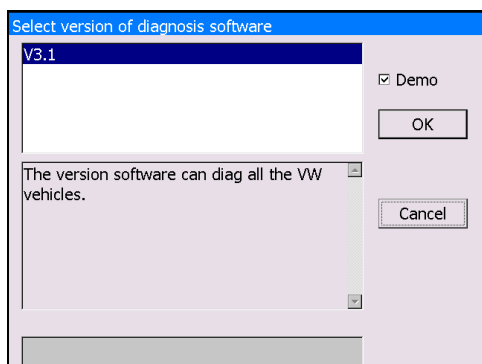

- (3) Select diagnostic program

Click on **[VW]**, for example, to enter software version selection screen shown in the left image.

Note: Program descriptions will be displayed under the version information.

- (4) Select a version such as V3.1 and click on **[OK]** as shown in left image. Click on **[Cancel]** to go back to the previous menu;

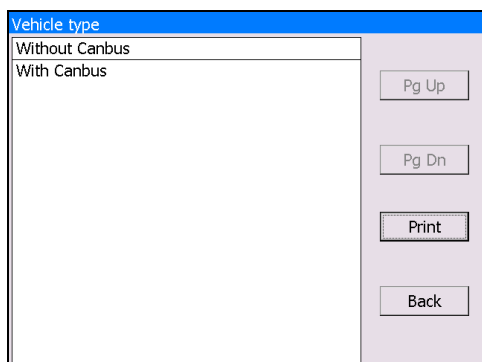

- (4) Select vehicle type: take Volkswagen/Audi for example, we have two vehicle types for selection: **[With Can bus]** and **[Without Can bus]**. Here we choose without Can bus car as an example to introduce the test.
- (5) **NOTE: VEHICLES WITH CAN BUS WILL HAVE DLC PINS 6 AND 14 POPULATED**

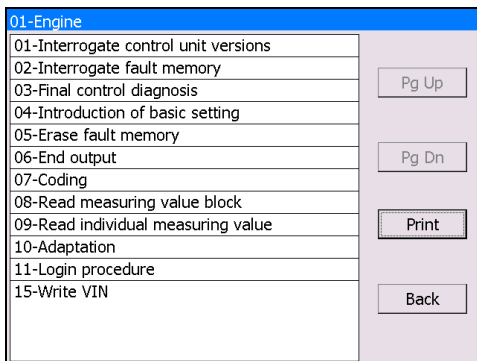
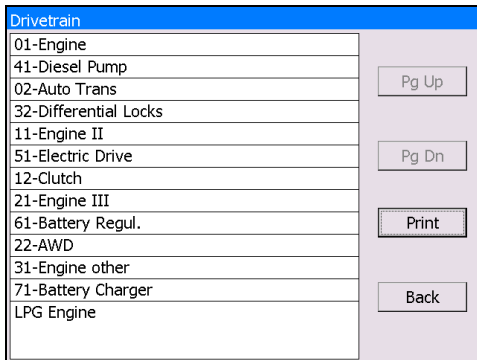
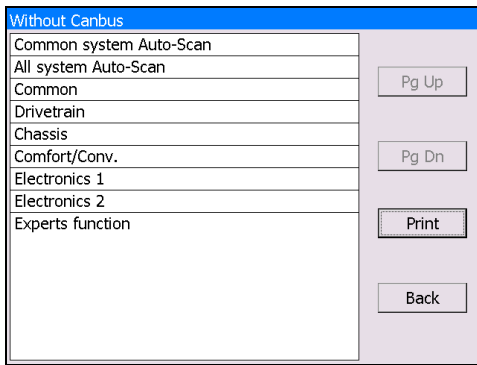

(6) Select system:

[Common system Auto-Scan]: Test the common-use ECU automatically;

[All system Auto-Scan]: Test all ECU automatically;

[Common]: by choosing this item, all common-use ECU will be displayed on the screen, users can then select ECU required accordingly;

Other systems: Enter the systems as per relevant ECU type.

(7) Click on **[Common]** to enter the screen shown on the left.

Select **[01-Engine]** to enter the screen with the following functions.

[01-Interrogate control unit versions]

[02-Interrogate fault memory]

[03-Final control diagnosis]

[04-Introduction of basis setting]

[05-Erase fault memory]

[06-End output]

[07-Coding]

[08-Read measuring value block]

[09-Read individual measuring value]

[10-Adaptation]

[11-Login procedure]

[15-Write VIN]

Note: Functions 04,07,10,15 require knowledge of the systems operation, please use with care.

Name	Value
VAG Number	B261204857
	M154_465Q-1A
	02_AA360217
	B261204857
	00AA360217

Pg Up Pg Dn Print Cancel

① [01-Interrogate control unit versions]

Click on [01-Interrogate control unit versions] to see the information of control unit as shown on the left.

Note: Read out old ECU codes with this function when performing ECU coding.

Fault Code	Description	status
000701	Coolant temp. out of tolerance	Open circuit or short to positive

Pg Up Pg Dn Help Print Cancel

② [02-Interrogate fault memory]

To display the DTC saved in the current control unit, click [02-Interrogate fault memory]. Please refer to the left image.

Name	Value
Idle speed adjust valve-N71	Testing ...

Print
Active Test
Back

③ [03-Final control diagnosis]

Click on the button [03-Final control diagnosis] to test relevant actuator automatically as shown on the left image. Click on [Active Test] to begin actuator test.

Input channel number:

1	2	3	4	5
6	7	8	9	0

Del Left Right Home End Enter

OK Cancel

④ [04-Introduction of basis setting]

Click on the button [04-Introduction of basis setting] for basic setting. Input desired number using the number keys and click on the button [OK] to start the basic setting.

- [Del]: Delete the input numbers;
- [Left]: Move cursor to left;
- [Right]: Move cursor to right;
- [Home]: Move cursor to Home;
- [End]: Move cursor to End;
- [Enter]: confirm enters.

Name	Value	Unit
Group Number	1	
	0.00	r/min
	-27.04	deg F
	72.39	%v.OT
	10000001	

The window of “Basic setting!” in left image will popup after Basic Setting is done.

- **[Input]**: continue to Input number;
- **[Back]**: Back to the Function Menu.

Note: Under basic setting mode, you can perform solenoid and engine control unit adaptation without starting the engine, or finish λ control process self-adaptation when engine starts. Also you can check faults or ignition timing by connecting or disconnecting λ control.

Fault Code erased

⑤ **[05-Erase fault memory]**

Click on the button **[05-Erase fault memory]** to erase DTC as shown on the left image.

- **[OK]**: Return to the previous menu

Do you want end diagnosis of this control unit?

⑥ **[06-End output]**

To exit from the diagnostic program, please click on **[06-End output]**.

- **[Yes]**: Exit the diagnosis program

[No]: Return to the previous menu

Input ECU number:

1	2	3	4	5
6	7	8	9	0

Del

Left

Right

Home

End

Enter

⑦ **[07-Code control unit]**

Click on **[07-Code control unit]** to go to screen as shown in the left image. Then input the code and click on **[OK]**, the scanner will begin the coding. Click on **[OK]** after coding succeeds.

Note: Please only code the ECU after the ECU has been changed or a function has been added (e.g. Cruise control). You can get the code of the old ECU by choosing **[01-Interrogate control unit versions], then recode the new ECU accordingly.**

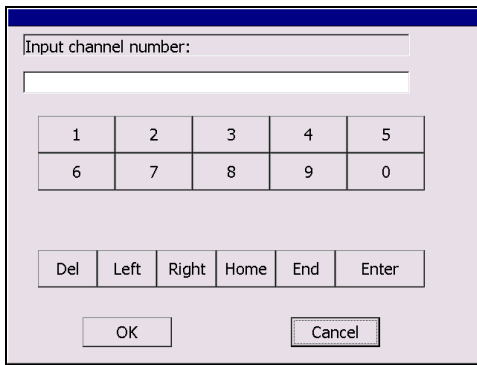

⑧ [08-Read measuring value block]

Click on **[08-Read measuring value block]** to enter screen shown in left image. Please input the relevant channel number, and click on **[OK]** to read data stream information.

Note: For channel definition, please refer to relevant technical manual.

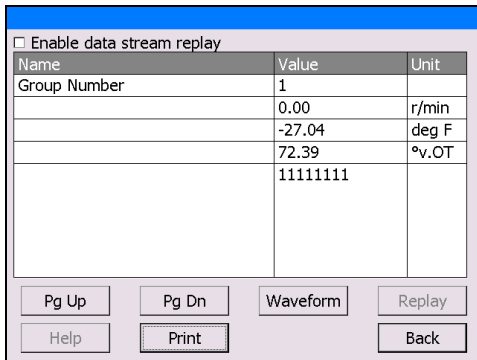

The left image is the data stream of Group 01.

- **[Page Up]**: See previous group data stream;
- **[Page Down]**: See next group data stream;
- **[Waveform]**: Review data stream in graph;
- **[Replay]**: Review data stream;
- **[Back]**: Return to the Function Menu.
- **[Print]**: save the current screen to SD card.

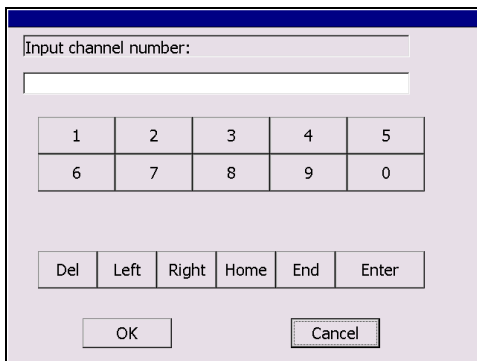

⑨ [09-Read individual measuring value]

Click on **[09-Read individual measuring value]** to enter the screen shown in the left image. Input the channel number and click on **[OK]** to view the relative data.

Click on **[Read Value]**, and current value will be displayed.

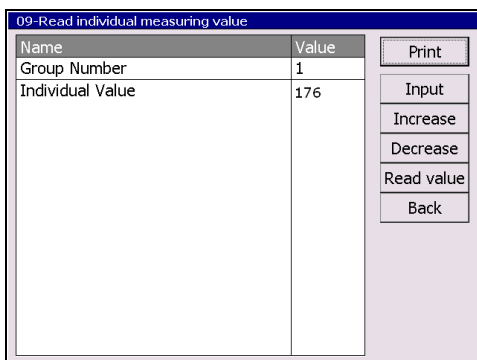

- **[Input]**: Back to the input screen;
- **[Increase]**: View the data of next channel number.
- **[Decrease]**: View the data of the previous channel number;
- **[Read value]**: Read current value;
- **[Back]**: Back to function list menu;
- **[Print]**: Save the current screen to SD card.

⑩ [10-Adaptation]

Click on **[10-Adaptation]** to enter the screen for inputting channel number as shown in left image.

Note: Self-adaptation includes: self-study during idle, service reset, IMMO adaptation and so on. You should login first for some of the functions. For login methods, please refer to

⑪ [11-Login procedure] on page 26.

Name	Value
Group Number	1

After inputting the relevant channel number, click on **[OK]** to enter the screen as shown in left image.

- **[Input]:** Back to the “input number” screen;
- **[Read]:** Read the adaptation value of current channel;
- **[Back]:** Back to function list screen;
- **[Print]:** Save the current screen to SD card.

Click on the button **[Read]** to read the adaptation value of current channel.

Name	Value
Group Number	1
Current Adaptation Value	150

- **[Input]:** Input new adaptation value;
- **[Back]:** Back to function list menu.
- **[Print]:** Save the current screen to SD card.

Click on **[Input]** in enter the “input adaptation value” screen shown on the left. Input the new value and then click the button **[Ok]** to go to the next step.

10-Adaptation	
Name	Value
Group Number	1
Current Adaptation Value	150
Input Adaptation Value	2

After inputting the new value, new adaptation value will be displayed on the screen. If no error is found, please click on the button **[Change]** to go to the next step.

10-Adaptation	
Name	Value
Group Number	1
Current Adaptation Value	150
Input Adaptation Value	2

Last step: Click on the button **[Save]** to save the new adaptation value and go back to the self-adaptation screen.

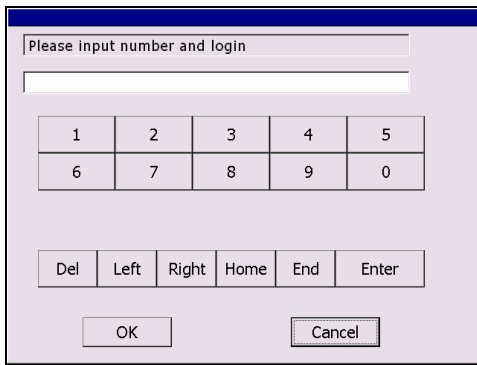

⑪ **[11-Login procedure]**

To perform adaptation in some group, login will be needed first. Just click on the button **[11-Login procedure]**, input the code number and then click on **[OK]**.

Note: Login is required when performing functions such as ECU coding, change channel adaptation and IMMO, etc.



⑫ **[15-Write VIN]**

Volkswagen/Audi uses the 3rd generation anti-theft technology, if you change engine control unit and instrument cluster at the same time you must rewrite the VIN code. Please click on **[15-Write VIN]** to input the new VIN.

- **[Del]**: Delete the input numbers;
- **[Left]**: Move cursor to left;
- **[Right]**: Move cursor to right;
- **[Home]**: Move cursor to Home;
- **[End]**: Move cursor to End;
- **[Enter]**: confirm the information.
- **[Shift]**:same with **[Caps Lock] + [shift]** function on key board

Order Information

AUTOBOSS TECH. INC.

Address: No.1102, Building B of Futian Tian'an Hi-Tech Venture Park, Futian District,
Shenzhen, China

Email: marketing@autoboss.net

Tel: +86-755-8832 3051 / 8832 3052 / 8832 3053

Fax: +86-755-8832 3012

Website: <http://www.AUTOBOSS.net>